

**NEW** FGA Fan Gasket

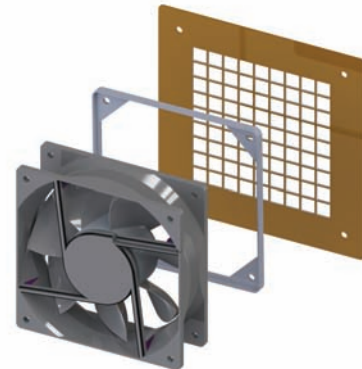

**Material: Silicone Rubber, 40 Shore A, RMS-101 Color: Black**

**Standard Pack: 100/Bag**

Part No.	Fan Size	Fan Hole Spacing	"D"	"F"	"G" Ref.
FGA-40	40	32	4.5	3.5	36
FGA-50	50	40			46
FGA-60	60	50	5	4	56
FGA-70	70	61.5			66
FGA-80	80	71.5			75
FGA-92	92	82.5		87	
FGA-120	120	105		115	

For free samples, visit [www.richco-int.com](http://www.richco-int.com)

**Richco**<sup>®</sup>

# FAN ACCESSORIES

## FMG

### Fan Mount Gasket

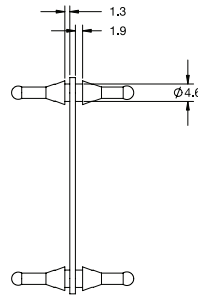
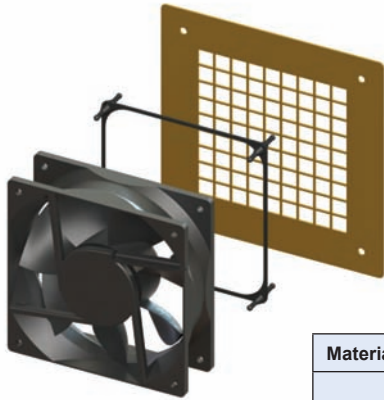

Fan Hole:  $5 \pm 0.1$   
Fan Thickness: 2

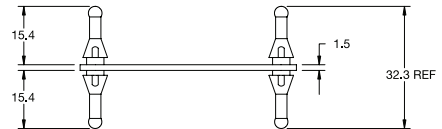
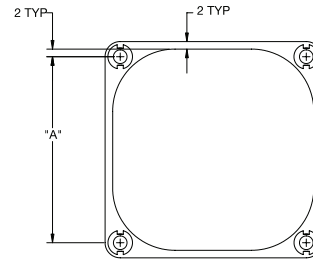

Material: EPDM Rubber 40 Shore A, RMS-180 Color: Black	
Standard Pack: 100/Bag	
Part No.	"A" Dimension
FMG-1	50
FMG-2	71.5
FMG-3	105.2

Panel Hole:  $5 \pm 0.1$   
Panel Thickness: 1.4

E

## FMPT

### Fan Mounting Frame

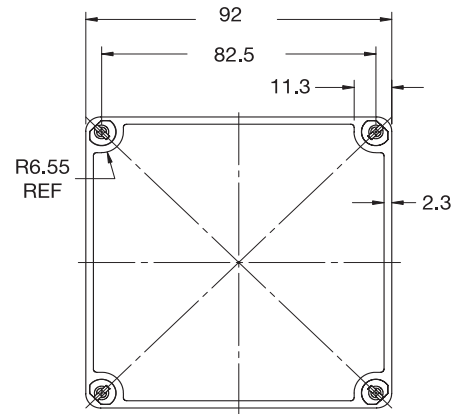
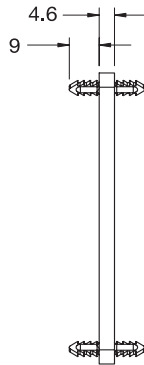

Material: UL94 HB ABS, RMS-59 Color: Black			
Part No.	Mounting Hole $\varnothing \times 4$	Min. Panel Thickness	Standard Pack
FMPT-92	$\varnothing 4.5$	3.7	40

## FMM

### Multi Fan Mount

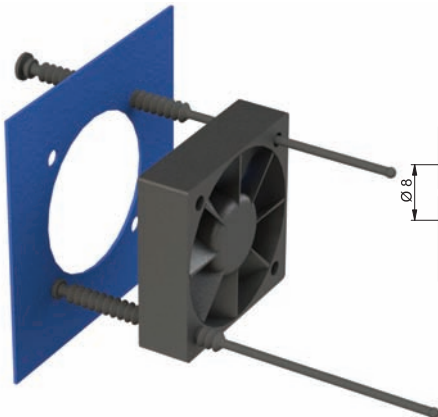

Patent Pending

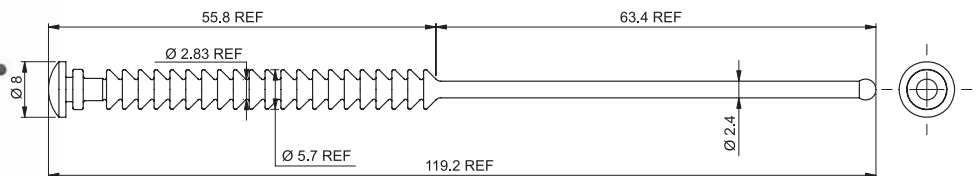

Material: Silicone Rubber 40 Shore A, RMS-316, Color: Black				
Standard Pack: 500/Bag				
Part No.	Fan Thickness	Fan Hole $\varnothing$	Panel Thickness	Panel Hole $\varnothing$
FMM-1	10 - 51	3.2 - 4.5	1 - 1.5	4.5 - 4.8

## FMB

### Break-Away Fan Mount

Fig. 1

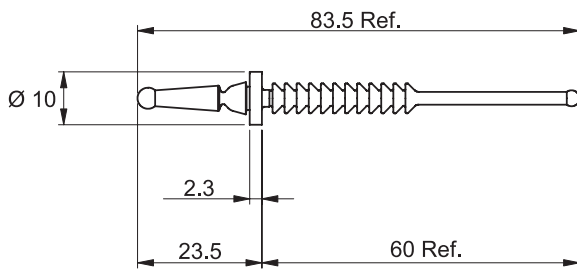
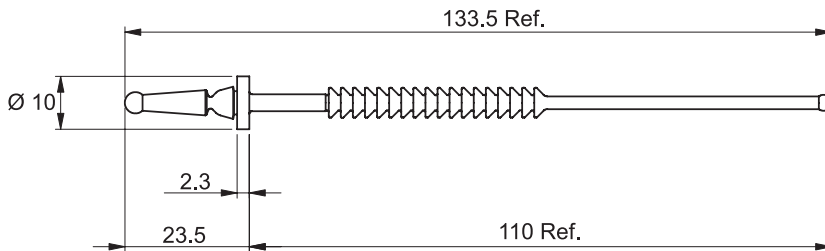

Fig. 2



Material: Silicone Rubber 40 Shore A, RMS-316, Color: Black

Standard Pack: 1000/Bag

Part No.	Panel Hole Ø	Panel Thickness	Fan Hole Ø	Fan Thickness	Fig.
FMB-1	4.5 - 5	0.8 - 1.6	4 - 4.5	25 - 51	2
FMB-2			3.2 - 3.5	Up to 10	1
			4 - 4.5	Up to 25	

E

Fig. 1

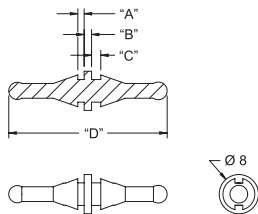
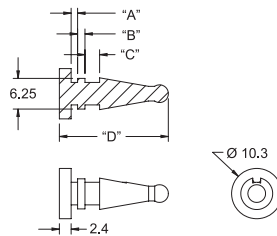

Fig. 2



## FM

### Fan Mounts

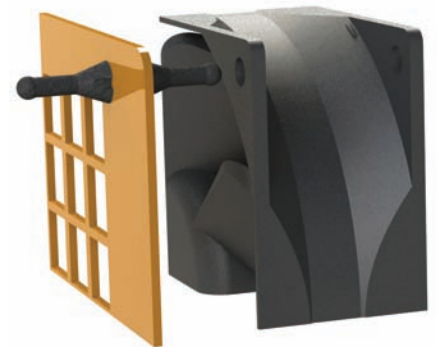

Fig. 3

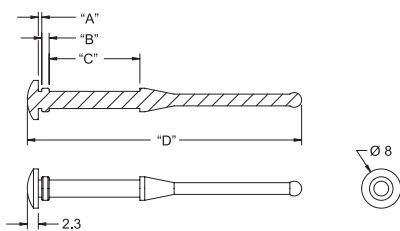
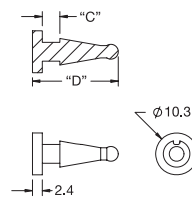

Fig. 4



Standard Pack: 1000/Bag

Part No.	Material	Color	"A"	"B"	"C"	"D"	Hole Ø x 2	Fan Thickness	Max. Panel Thickness	Fig.
FM-1	EPDM Rubber, 30 Shore A, RMS-166	Black	1.3	1.5	1.9	32.3	5	2	1.4	1
FM-2	EPDM Rubber, 40 Shore A, RMS-180				3	22.2		3.1		
FM-3	EPDM Rubber, 30 Shore A, RMS-166				0.7	18.5	56	3.5		20
FM-4	EPDM Rubber, 40 Shore A, RMS-180		2.5	2	14	53.8	4.3	15	3	3
FM-5	Silicone Rubber, 40 Shore A, RMS-316		0.7	1.5	24	73	3.5	25 - 28	0.8	
FM-6			-	-	4.3	21	5	5.4*	4	
NEW FM-7	EPDM Rubber, 30 Shore A, RMS-166									
NEW FM-8	EPDM Rubber, 40 Shore A, RMS-180									

\* Maximum combined panel and fan thickness

# FAN ACCESSORIES

## SR-3230B

Snap Rivet (Long)

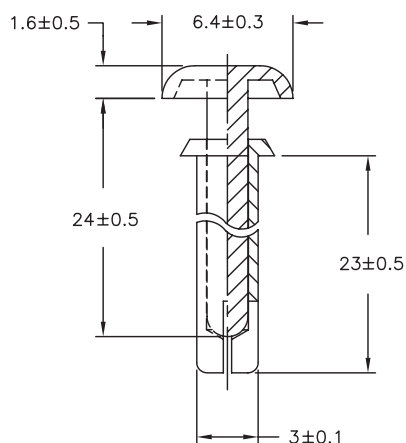

Material: Nylon 6, RMS-52 • Color: Black

Part No.	Standard Pack: 1000/Bag		
	Mounting Hole Ø	Panel Thickness	Extraction Force
SR-3230B	3.1-3.2	20.5-21.5	8kg min.

E

## FR-1

Fan Mount Rivet



**NEW**

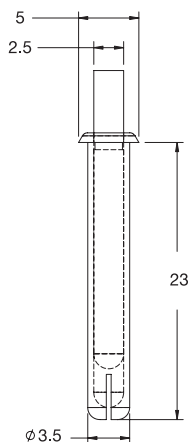

Material: UL94 V-2 Nylon 6, RMS-52 Color: Black

Part No.	Hole Ø	Standard Pack: 1000/Bag	
		Mounting Thickness	Installation Tool
FR-1	3.5	20.5 - 21.5	PPR-T1